

## Supplement 9 - Ultramagic SOLO / DUO

### 9.1 General Information

This supplement details the instructions and limitations necessary to ensure the safe operation, maintenance and continued airworthiness of the Ultramagic SOLO / DUO.

The Ultramagic SOLO is capable of carrying a single pilot and consists of a seat and harness assembly, a special fuel cylinder and a burner designed specifically for use with the equipment. The Ultramagic DUO can carry the pilot plus one passenger. The seat and harness assembly and the fuel cylinder are mounted on to a main frame. The main frame is a welded stainless steel tube construction. The burner is mounted in a welded stainless steel tubular frame. The frame allows single axis burner gimbal and provides the interface to the envelope flying wires.

The burner and main frames may be detached from one another for the purposes of transportation. During flight, they are secured using four shaft-locking pins.

The SOLO / DUO burner is essentially a variant of the Ultramagic Single and as such, independent duality of all functions is provided.

The SOLO is available in three options. The standard variant is designed for flight only. The PowerPlus variant is designed in order to allow the use of the PowerPlus Sport burner. The Flyker variant is provided with additional equipment allowing it to be attached to a special bicycle enabling it to be towed as a small trailer. The DUO has just the standard option.

This supplement covers only those aspects related to flight.

The SOLO may be seen in Figure 1.1 in both configurations and the DUO in Figure 1.2

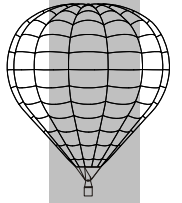

S  
9  
S  
O  
L  
O  
-  
D  
P  
O

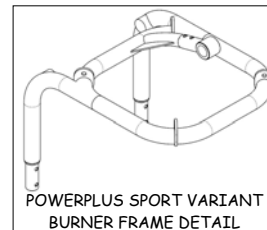
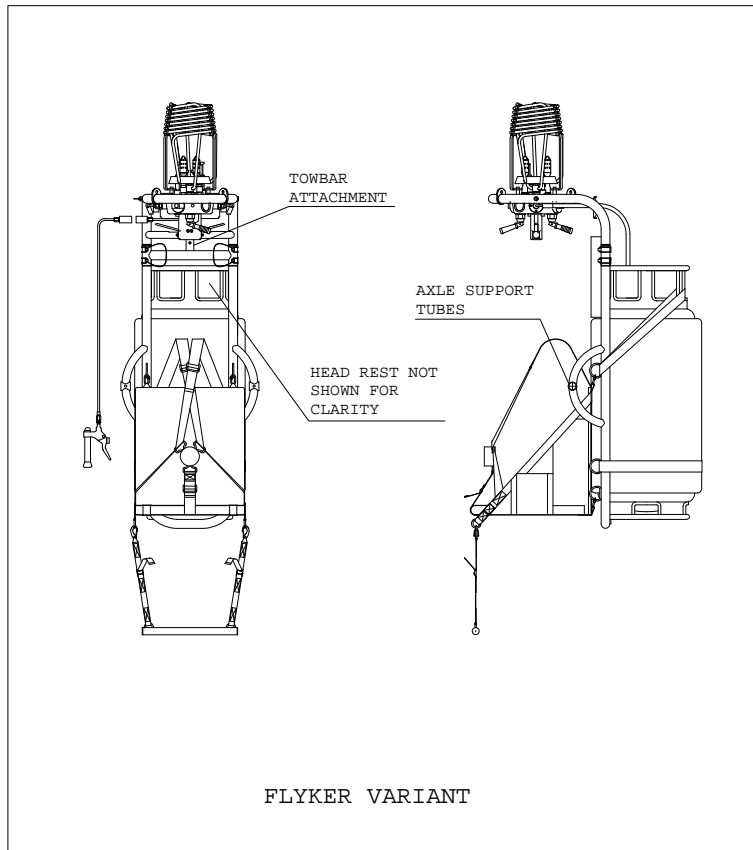
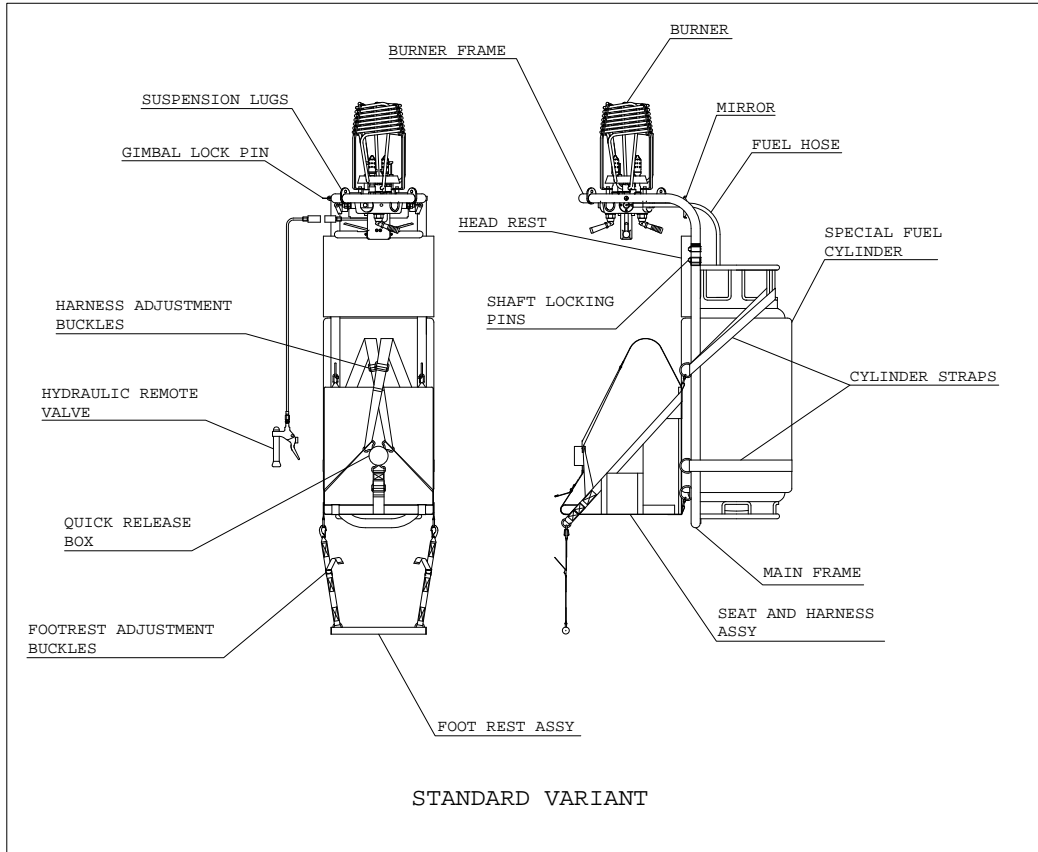
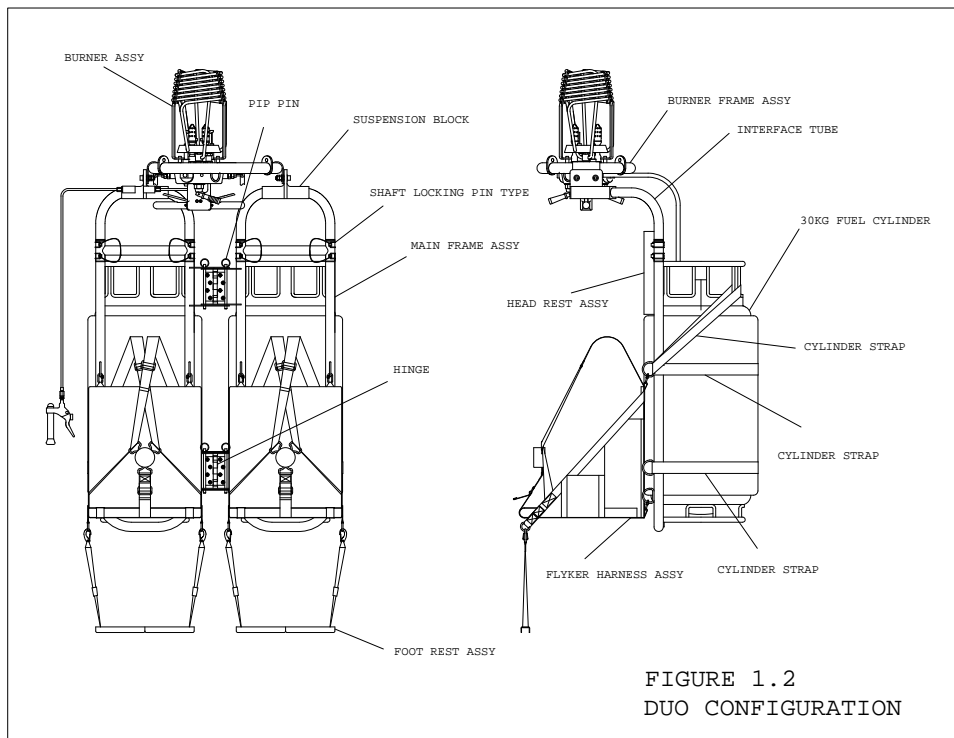

FIGURE 1.1  
SOLO CONFIGURATIONS



## 9.2 Operational Limitations

The following limitations are additional to those already stated in the Flight Manual.

### 9.2.2 Wind Speed

The maximum surface wind speed for takeoff and landing is 10 knots.

### 9.2.4 Safety Equipment

SOLO/DUO bottom ends are exempt from carrying a fire extinguisher.

### 9.2.7 Number of Occupants

No more than one person may occupy the seat at any one time with the SOLO and two persons for the DUO.

### 9.2.12 Minimum Burner Requirements

The SOLO may only be operated with the Ultramagic SOLO Burner type 2025-0000 or the PowerPlus Sport burner type 2031-0000. The DUO will be operated with the Ultramagic SOLO Burner with the standard coil of the Single burner MK-21.

### 9.2.13 Fuel Cylinder

The standard equipment is with the Ultramagic 30kg SOLO Fuel Cylinder type 4004-0000, fitted with a padded jacket of minimum thickness 25mm. One for the SOLO and 2 cylinders for the DUO.

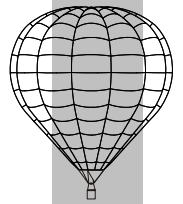

The SOLO is allowed also to fly with a standard 20 Kg, 30 Kg or 40 Kg Fuel Cylinder with a T connection. The DUO is permitted also to fly with 2 standard 20 Kg, 30 Kg or 40 Kg Fuel Cylinder.

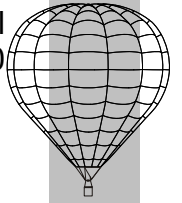

#### **9.2.14 Fuel Pressure**

In order to prevent heat damage to the envelope, the equipment must not be operated if the fuel pressure exceeds 8 Bar (120 psi).

#### **9.2.15 Envelope**

The equipment may only be operated with envelopes fitted with rotation vents.

#### **9.2.16 Refuelling**

Detach the cylinder prior refuelling to prevent the equipment from over-balancing.

#### **9.2.17 Harness Quick-Release Box**

The harness quick release box must not be operated during flight. It may only be operated after landing, when the equipment has come to a complete stop and when the pilot judges it safe to vacate the seat.

#### **9.2.18 Bicycle**

When used in Flyker mode, the equipment may only be used with the bicycle supplied by Ultramagic.

### **9.3 Emergency Procedures**

No change.

### **9.4 Standard Procedures**

The following procedures are additional to those already contained in the Flight Manual.

#### **9.4.5 Assembling the SOLO / DUO and Preparation for Flight**

The SOLO / DUO consists of a series of major assemblies, which must be correctly assembled to ensure safe operation. From now on we will refer to the SOLO assembly, being for the DUO a very similar system. To assemble the SOLO, refer to Figure 1 and proceed as follows:

Attach to seat and harness assembly to the main frame by hooking the four quick links on the rear of the seat into the "D" lugs on the front of the main frame. Ensure the quick links are fully tightened.

Assemble the fuel cylinder to the rear of the main frame. Make sure that the cylinder base ring sits over the retaining bracket on the base of the main frame. Secure the cylinder to the main frame using the three cylinder straps. Note that it

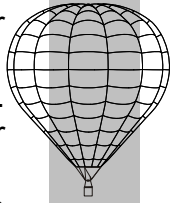

is important to position the straps as shown in order to ensure that the cylinder cannot move or rotate. Make sure the straps are tight.

Fit the burner frame assembly into the two sockets on the top of the main frame. Take care to prevent the equipment over-balancing at this stage. Ask for assistance if necessary.

Insert the four shaft locking pins through the holes in the sockets and rotate the spring clips into the locked position.

When using the PowerPlus Sport burner make sure that the two shaft locking pins going through the holes in the burner's detachable arm are inserted and locked.

Fit the padded headrest to the front of the main frame and secure in position using the Velcro straps.

Check that the cylinder fuel valves are OFF. Attach the burner fuel hoses to the mating couplings on the fuel cylinder. Note that it is very important to ensure that the left burner fuel hose is assembled to the left cylinder fuel coupling and that the right fuel hose is attached to the right cylinder fuel coupling.

Fit the mirror into the two plastic bushes on the burner frame.

Attach the foot rest assembly to the two "D" lugs on the side of the seat and harness assembly using the two snap hooks on the ends of the foot rest tapes.

The following flight preparation procedures are additional to those already contained in the Ultramagic Flight Manual.

Attach the envelope karabiners sequentially to the four rapid links fitted in the suspension lugs on the burner frame. Ensure that all karabiner and quick link gates are closed and tight. Make sure that the envelope orientation is such that all control lines may be easily reached from the seat.

When using the Ultramagic SOLO burner, withdraw the gimbal lock pin in the burner frame prior to inflation.

Inflate with the help of at least two assistants. The assistants must hold down and steady the equipment whilst the pilot secures himself into the seat.

Insert the two harness tangs in to the quick release box. Adjust the harness straps so that the pilot is fully secure and the harness and seat are comfortable.

Adjust the footrest tapes to suit.

When using the Ultramagic SOLO burner, release the gimbal lock pin and lock the burner in the vertical position.

Set the mirror so that a reflection of the cylinder fuel contents gauge is clearly visible.

**Note: It is strongly recommended that the pilot (and the passenger in the DUO version) wear a suitable hard protective hat for the duration of the flight.**

If the equipment is to be used to carry the bicycle associated with the equipment, it must be carried in the supplied bag and suspended below the equipment by attaching the bag to one of the main frame "D" lugs.

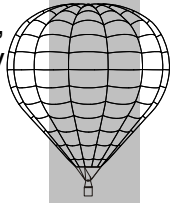

#### 9.4.8 Pre-flight Checks

The following pre-flight checks are additional to those already contained in the Ultramagic Flight Manual.

Check that:

All four shaft-locking pins are fitted and secure.

All load tapes used in the harness and seat construction are in good condition.

All four harness quick links are attached to the main frame and that their gates are closed and tight.

The fuel cylinder is full.

All envelope karabiners and the quick links fitted to the burner frame suspension lugs are secure and that the gates are closed and tight.

The fuel cylinder is fully secured to the main frame.

The harness tangs are secure within the quick release box.

The harness straps are correctly adjusted.

#### 9.4.10 Fuel Management

The fuel cylinder is provided with two fuel feeds. As an additional safety feature, the right hand fuel feed is fitted with a dip tube, which provides access to the first eighty percent of the total fuel contents in the cylinder. By using only the right hand main and liquid burner valves until the right hand fuel supply is exhausted, the pilot is provided with an effective warning that the fuel remaining is only twenty percent.

To ensure that this system operates correctly it is very important that the connection of the fuel hoses to the cylinder is correct (see section 9.9.4.5) and that only the right hand (blue) main and liquid burner valves are used until the first eighty percent of the fuel is exhausted. When the right hand fuel supply is exhausted, the pilot must continue flight using the left hand main and liquid burner valves. Upon switching to the left hand fuel supply, the pilot should begin making preparations for landing. Note that both pilot lights must be lit throughout the duration of the flight.

Irrespective of the use of the above system, the pilot must continually monitor fuel contents by checking the fuel cylinder gauge in the mirror.

When used with a standard cylinder, the pilot must control continually the fuel contents with the mirror. In all cases pilot should land when remaining a 20 % of propane in the cylinder or less.

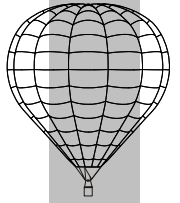

**9.4.11 Landing**

Prior to any landing, select the envelope parachute line and keep it in the hand ready for use.

If the wind conditions are light, use the legs to absorb some of the downward velocity.

If a fast landing is anticipated, use the envelope rotation vents to orientate the equipment such that the pilot’s back faces the direction of motion. Do not use the legs to absorb the landing impact. Rather, allow the bottom of the cylinder and the seat to absorb the landing loads and prepare for the resulting drag to be on the side.

**9.4.12 Post Flight Instructions**

Store the equipment in such a way as to prevent it from overbalancing. To prevent damage, the equipment should be stored in the protective bags provided.

**9.5 Loading**

**9.5.2 Table of Empty Weight and Maximum Lift**

Model	Bottom	Pv	Lmax
V-25	SOLO	61	250
H-31	SOLO	72	300
	DUO	80	300
H-42	SOLO	81	300
	DUO	89	400
M-42	SOLO	90	300
	DUO	98	400
H-56	DUO	100	450
M-56	DUO	109	450
S-50	DUO	78	450
S-70	DUO	89	450

Pv = Empty Weight (kg) without cylinder.

Lmax = Maximum Lift (kg) authorised.

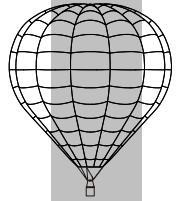

9.5.4 Table of Compatibility

MODEL / SIZE	25	31	42	50	56	70
SOLO	*	*	*			
DUO		*	*	*	*	*

9.6 Balloon and Systems Description

9.6.2.5 Controls and Control Functions

Burner

The configuration and function of all burner controls are as described in the Ultramagic Flight Manual.

**Note that the use of the right and left main and liquid burner controls is of great importance for the correct fuel management of the equipment (see section 9.4.10).**

Burner Frame Gimbal Lock Pin

The standard and the Flyker variants are provided with a single axis burner gimbal for the purposes of envelope inflation. During flight, the gimbal action must be locked using the lock pin fitted in the side of the burner frame.

Withdrawing the pin enables burner gimbal action. The pin may be held in the withdrawn position by rotating it through 90 degrees. Returning the pin to the retracted position prevents further gimbal action after the burner has been returned to the vertical position. The pin may be seen in Figure 2.

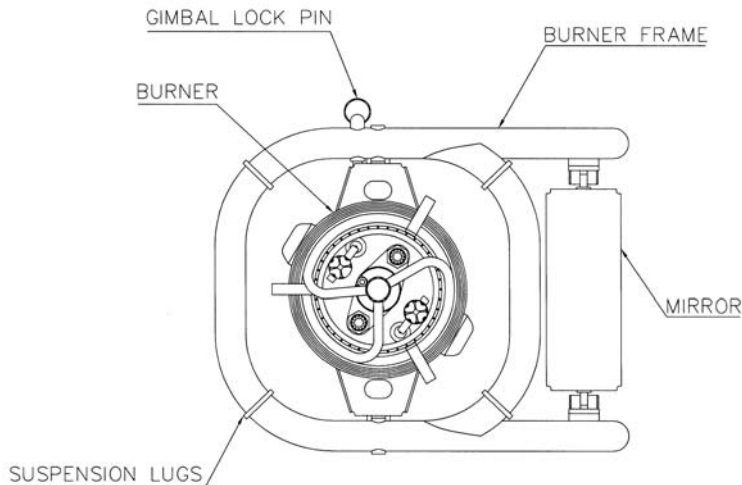
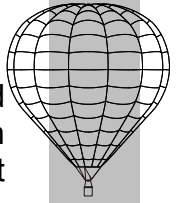

FIGURE 2  
BURNER FRAME ASSEMBLY





**Fuel Cylinder**

The configuration and function of all controls on the fuel cylinder are as described in the Ultramagic Flight Manual. Note that the fuel cylinder is fitted with an additional liquid fuel feed allowing fuel supply to the independent left and right fuel systems in the burner.

**Note that the identification of the left and right fuel valves on the cylinder is of great importance for the correct fuel management of the equipment (see section 9.4.10).**

**Harness Quick Release Box**

The pilot harness is fitted with a rotary action quick release box. Prior to flight, the harness tangs are inserted into the quick release box thus securing the pilot into the seat. Rotating the outer knob releases the two tangs fitted to the harness shoulder straps allowing the pilot to vacate the seat.

**Harness Adjustment Buckles**

Three adjustment buckles are provided on the pilot harness. The buckles are self-locking and retain their position when released. Adjustment of the harness is achieved by pulling on the webbing to shorten and by pulling on the buckle to lengthen.

**Envelope Controls**

No change

**9.6.3 Dimensions and Weights**

**BURNER**

Model	SOLO / DUO Burner	PowerPlus Sport
Mass (kg)	9,5	9

**BASKET Bottom End**

Model	SOLO (Excluding Cylinder And Burner)	DUO (Excluding Cylinder And Burner)
Mass (kg)	11,5	19,5

## CYLINDER

Model	Flyker Cylinder	M-20	M-30	M-40
Mass (kg)	22	15	22	24
Full (Kg)	52	35	52	64

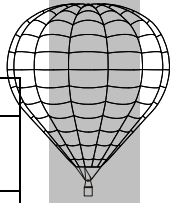

### 9.7 Balloon Handling Maintenance and Care

Instructions for the Maintenance, Handling and Care of the SOLO / DUO are contained in the Maintenance Manual Supplement No. 4.

### 9.8 Other Manufacturers Equipment

No change.